

THE BROADCAST ENGINEERS' JOURNAL
116-03 91ST AVENUE, RICHMOND HILL 18, N. Y.

POSTMASTER: IF UNDELIVERABLE FOR ANY
REASON, NOTIFY SENDER, STATING REASON.
ON FORM 3547, POSTAGE FOR WHICH IS
GUARANTEED

F A GEHRES WGBF-WEOA
2232 E POWELL
EVANSVILLE 14 IND
5145

Sec. 562, P. L. and R.

U. S. POSTAGE
PAID

New York, N. Y.
Permit No. 2961

The Broadcast Engineers' Journal

Since 1934 . . .

Of, By, and For

The

Broadcast

Engineer

VOL. 11
No. 8

**BUY
BONDS**

. . . AUGUST : 1944 . . .

GOULD-MOODY "BLACK SEAL" GLASS BASE INSTANTANEOUS RECORDING BLANKS . . .

RECORDING AMERICA'S POWERFUL VOICE

Transmitter of America's Powerful Voice is Radio . . . awake twenty-four hours a day . . . talking to our friends and our enemies . . . transporting Broadway and Hollywood and the girl next door to the boys over there . . . building morale on the home front.

Recording America's Powerful Voice . . . in leading broadcasting stations from coast-to-coast . . . are Gould-Moody "Black Seal" Glass Base Instantaneous Recording Blanks. Made entirely of glass, "Black Seals" are as thin as aluminum, thereby eliminating the necessity of recorder adjustments. No foreign inserts . . . no metal grommets . . . no ageing, hardening or deterioration. Every disc has four holes . . . center-flow thread action . . . may be played back for months without appreciable loss of fidelity. Enclosure of your preference rating extensions with your order will expedite deliveries.

SHARE YOUR BLOOD WITH A WOUNDED SOLDIER
— donate a pint to the Red Cross today

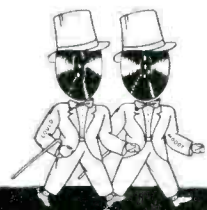

THE GOULD-MOODY COMPANY

RECORDING BLANK DIVISION

395 BROADWAY, NEW YORK 13, N. Y.

THE BROADCAST ENGINEERS' JOURNAL

Contents Copyright, 1944, by A.T.E. Publications, Inc.

Volume 11, No. 8



August, 1944

TABLE OF CONTENTS

	Page
The Polarization of U-H-F Waves.....	3
The 6J4 Grounded-Grid U-H-F Triode.....	7
Elemental Electronics, Part VIII— Peaking Circuits	9
From Hollywood	12
From San Francisco.....	14
KFI-KECA News	15
New York News.....	16
New Television Stations.....	17
Diary of a Plain Squirt Operator.....	18
Chicago Chapter Chatter.....	20
U-H-F Relays Authorized.....	21
Hudson Chapter NABET News.....	22
Radio and the Railroads.....	22
The Winker System.....	24

THE BROADCAST ENGINEERS' JOURNAL

Trustees: V. J. DUKE, H. E. HILLER, G. B. RILEY, R. A. SCHLEGEL,
D. A. ULLMAN

ED. STOLZENBERGER
Managing Editor

Coordinator..... F. R. ROJAS
Treasurer..... C. W. PHELAN
Assistant Treasurer..... D. J. MOLONEY
Contributing Photographer..... SERGEI DE SOMOV

ASSOCIATE EDITORS

Chicago..... A. W. HJORTH
Cleveland..... BERT PRUITT
Denver..... KENNETH N. RAYMOND
Engineering Chapter..... V. J. DUKE
Hollywood..... NORMAN DEWES
Hudson Chapter..... RICHARD H. DAVIS
KFI-KECA..... E. F. WILMSHURST
New York..... G. F. ANDERSON, JR.
San Francisco..... S. A. MELNICOE
Washington..... R. E. SHENTON
WLW-WSAI-WLWO..... HOMER A. RAY, JR., BOB BROCKWAY
WOW, Omaha..... ROY "TEX" GLANTON
WPTF, Raleigh..... H. W. ROOD

The Broadcast Engineers' Journal is a privately printed monthly publication issued by A.T.E. Publications, Inc., a corporation of the State of New Jersey. Address all communications to Editor's office: E. Stolzenberger, 116-03 91st Avenue, Richmond Hill 18, L. I., N. Y. Telephone Virginia 9-5553. **THE BROADCAST ENGINEERS' JOURNAL IS THE OFFICIAL PUBLICATION OF THE N.A.B.E.T.**

Advertising rates and information supplied on request. Subscription, \$1.50 per year; \$3.00 for three years. Single copies, except Christmas Yearbook, 25c; Christmas Yearbook free to subscribers. All remittances in advance. Foreign: Add postage.

Nothing appearing in The Broadcast Engineers' Journal shall be construed to be an expression of The Broadcast Engineers' Journal or the National Association of Broadcast Engineers and Technicians, but must be construed as an individual expression of the author or authors.

NATIONAL N.A.B.E.T. OFFICE
Suite 1009, Investment Bldg., Washington 5, D. C.
A. T. Powley, President



This War . . .

is daily emphasizing the importance
of dependability and permanence in
all of our equipment.

**This is especially true of
Radio Recording
Equipment**

The Test of Time has proven

**SCULLY
Master Recorders**

to be unsurpassable as precision,
superb recording machines

**BUY U. S. WAR BONDS NOW
and plan to install
SCULLY MASTER RECORDERS
After the Victory!**

**SCULLY
Machine Company**

62 Walter Street

Bridgeport, Conn.

Telephone BRidgeport 4-5300

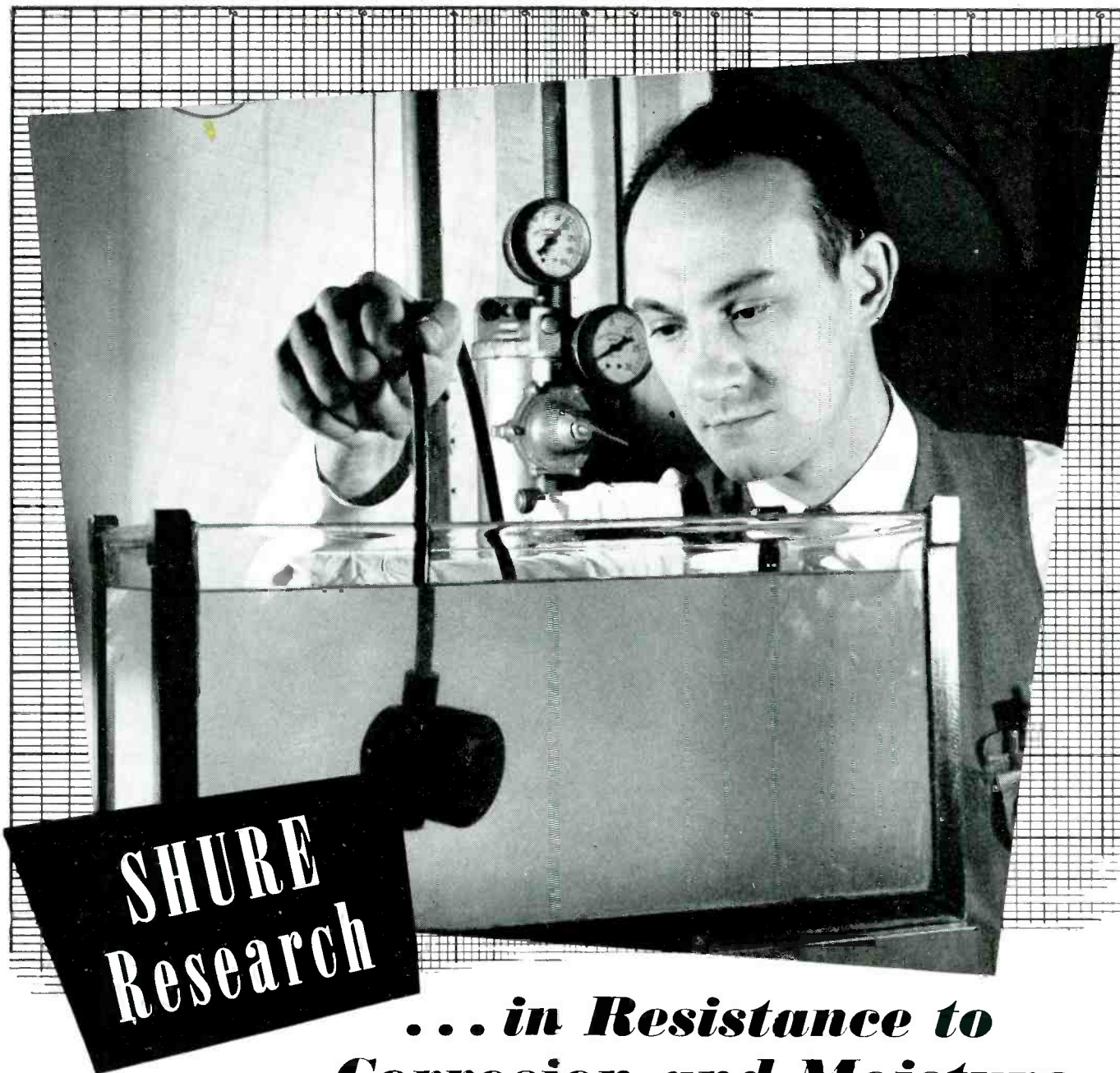

... in Resistance to Corrosion and Moisture

This is a standard test at Shure Brothers. The microphone is connected to the air pressure line and submerged. No bubbles—its “insides” are protected against rain and ocean spray. More than that, Shure engineers have successfully defeated corrosion of iron, steel, brass and aluminum microphone parts—and they were the first to moisture-proof, successfully, Rochelle Salt Crystal Microphones. You may well look to Shure engineers to provide you with better microphones and headphones.

SHURE BROTHERS, 225 West Huron Street, Chicago
Designers and Manufacturers of Microphones and Acoustic Devices



Polarization of U-H-F Waves

(NOTE: The term ULTRA HIGH FREQUENCIES is generally accepted as relating to those frequencies of the radio spectrum lying between 300 and 3000 megacycles. These radio waves, between 10 centimeters and 1 meter in length, are sometimes known as microwaves or centimeter waves.)

Second in a Series of Articles on Microwave Transmission and Reception

By Jordan McQuay

ENERGY waves radiated by an antenna at any radio frequency are both electric and magnetic in nature, and are therefore known as electromagnetic waves. These waves have two field components: an electric field and a magnetic field, which are at right angles to each other and also at right angles to the direction in which energy is propagated. The principles governing radiation and propagation of electromagnetic energy are based upon the laws that (1) a moving electric field creates a magnetic field, and conversely (2) a moving magnetic field creates an electric field. And this entire structure propagates itself through space with the speed of light.

Although the electric field and the magnetic field cause the existence of each other, it has become customary to consider radiation, propagation, and reception of radio waves in terms of the electric field.

The lines of force constituting the electric field have a varying intensity. And the movement of the electric field through space can be regarded much as the expansion and contraction of an electric field between the plates of a large fixed condenser.

Further, the lines of force have a characteristic polarity, depending upon the plane within which lie these lines of electric force. The polarity of the electric field radiated from an antenna system will determine the polarization of the emitted radio wave. And it is with this important property of radio wave polarization that we are concerned in this article.

When the orientation of a radio wave is such that all the lines of force lie in planes perpendicular to the ground, the wave is said to have *vertical polarization*. When the orientation of a radio wave is such that the lines of electric force are parallel to the ground, the wave is said to have *horizontal polarization*. Thus, an antenna which is vertical with respect to the earth radiates a vertically polarized wave, and a horizontal antenna radiates a horizontally polarized wave.

When the electric field has both vertical and horizontal components of polarization, the radio wave is said to have either *elliptical* or *circular* polarization. This is a special variation of type, and will be considered later.

So far in this discussion our technical statements have been general with respect to operating frequencies; in other words, these principles pertain to low, medium, high and ultra high frequencies.

But in the u-h-f range of operation—at frequencies

higher than 300 megacycles, or wave lengths shorter than 1 meter—radiation, propagation, and reception of radio waves in some respects are considerably different than for lower frequencies of operation. The polarization of u-h-f waves plays an important role in this difference.

For one thing, the *sky wave*—so important at lower frequencies for long distance transmissions—is almost useless at the ultra high frequencies. This is because u-h-f radio waves radiated upward toward the ionosphere are *not* reflected back to earth, but travel through the ionosphere with only slight refraction and are lost in outer space.

The u-h-f *ground wave* is vertically polarized—just as the ground waves of lower operating frequencies. And, similarly, this is because all of the horizontal electric field components of the radio wave are effectively short-circuited to earth—due to the good conductivity of the ground. Some attenuation of the vertical electric field components is also present, however, and a pure ground wave at ultra high frequencies cannot be relied upon for consistent transmission over any considerable distance. And, of course, the ground wave plays no part in air-to-ground or air-to-air transmissions.

But u-h-f radio waves which just clear the ground and travel in more-or-less of a straight line to the receiving antenna, *without being reflected but often being refracted by the atmosphere*, are widely used for microwave transmission and reception. These waves are known as *direct waves*, and have some characteristics similar to the “parent” ground wave. But the direct wave—*unlike the ground wave*—can have any desired polarization: horizontal, vertical, diagonal, or a combination.

Considerations of u-h-f operation and propagation always imply the use of these *direct waves*—the only consistent and reliable means of transmission with ultra high frequencies. The *direct wave* can be compared to a light wave, in many respects. The *direct wave* travels in almost a straight line, between transmitter and receiver. The wave may be slightly refracted by the atmosphere or other causes, however, which permits transmission of signals over distances exceeding the so-called “line of sight,” or horizon distance. But for all intents and purposes, the *direct wave* can be considered to be almost a straight line.

These u-h-f *direct waves* readily show the effects of polarization.

For instance, if a horizontal dipole antenna is used for radiating a u-h-f *direct wave*, a similar (horizontal) antenna

U-H-F WAVES

must be used at the receiver to obtain optimum results. The transmitting and receiving antennas should always be parallel to one another, in the same geometric plane—regardless of the intervening distance. A u-h-f system of radio transmission will only function with maximum efficiency, when the respective antennas are arranged parallel to one another.

Similarly, if a vertical dipole is used as a radiator, a vertical dipole must be used at the receiver to obtain the best results. Or, if the transmitting dipole is arranged diagonally—at some oblique angle, between the horizontal and vertical—the receiving dipole must also be arranged parallel to the radiator.

The use of other than parallel arrangements of antennas may result in passable reception, but the received signal level will be much lower than would be the signal from antennas mounted parallel to one another.

Polarization fading is another disadvantageous result of mismatching u-h-f antennas. This transient effect is caused by variations in the state of polarization of the radio wave relative to the orientation of the receiving antenna. When the polarization is such that the electric force in the wave has a large component in the direction of the receiving antenna, the resultant induced antenna voltage is large; when the component is small, the induced voltage is also small.

The polarization characteristics can be made quite distinct and precise at ultra high frequencies by the use of special antenna arrays. Since the horizontal component can be so easily differentiated from the vertical component, complex u-h-f systems have been designed which employ polarization to good effect. Two electrically separate u-h-f transmission systems can be used on the same operating ultra high frequency and in the immediate vicinity of each other, with none of the usual bad effects resulting from operation of lower frequency transmission systems at such close proximity to each other. If the transmitter and receiver antennas of one u-h-f system are mounted horizontally and the antennas of the second system are mounted vertically, the two u-h-f systems may be operated without mutual interference. While the technical operation of such an arrangement is somewhat critical—and not always possible because of certain extraneous factors unrelated to polarization—this is an important and direct utilization of the polarization characteristics of radio waves, and has important ramifications.

In general, it has been found that horizontally polarized u-h-f waves generally give the best results for short range transmission, while waves having vertical polarization are used for long range u-h-f operation.

When a radio wave of any frequency is *reflected*—by mountains, buildings, large metal surfaces, or the ionosphere—the phase of the wave is altered with each reflection and a definite amount of polarity change takes place. If the radio wave travels an appreciable distance and is also reflected a number of times, the resultant wave at the receiver will be a

combination of several or many signals each having different phase relationships and therefore different polarizations. A complete analysis of this action is far too complex to be considered in any detail, but the result at the receiving antenna is a radio wave having a combination of both horizontal and vertical polarization components. This is known as elliptical or circular polarization. If the horizontal and vertical components are equal and balanced in opposite magnitude, the polarization will be circular; if the horizontal and vertical components are unequal, the polarization will be elliptical.

This type of random polarization is extremely undesirable. But u-h-f waves probably suffer less from this random polarization change than do radio waves of lower frequency.

However, elliptical and circular polarization can be deliberately employed with certain complex transmitter-receiver systems. These systems employ arrangements of crossed dipoles at both the transmitter and receiver. If the r-f energy at the transmitter is applied to one dipole 90 degrees out-of-phase with the signal applied to the other (crossed) dipole, the resultant radiation will be circularly or elliptically polarized. To intercept and receive such a complicated signal, a similar arrangement must also be used at the reception terminus of the u-h-f system, and both the transmitter and receiver must be properly synchronized with each other. Needless to say, such a complicated means of obtaining elliptical or circular polarization is difficult to adjust and properly synchronize.

All of these several means of obtaining precise polarization of u-h-f waves result from a desire to obtain a high degree of power transfer and efficiency as well as security of radio transmission. This article has shown how the polarization characteristics of u-h-f waves may be put to an excellent use.

Predictions of an electronics era in postwar days were made by H. L. Hoffman, president of the West Coast Electronics Manufacturers Association, May 14, over KMPC, Hollywood, during the Los Angeles Times' "Everybody's Hour" at 6 p.m. (Pac. war time).

The weekly broadcast, a series recently launched by the newspaper, devotes a portion of each half hour to a talk by a spokesman representing outstanding Southern California industries. Donald Douglas, of the airplane industry, and Leonard Firestone, representing the rubber industry, were speakers earlier in the series.

Mr. Hoffman, who is also president of the Hoffman Radio Corp., Los Angeles, in non-technical language briefly interpreted trends in the electronics field of the west coast. Manufacturers, who are now devoting their facilities 100 percent to electronics output for the army and navy, are expected to continue in postwar days with continuing employment for workers, and even greater plant expansion in capital investment and production facilities.

F. U. N. E. M. N. X. ?

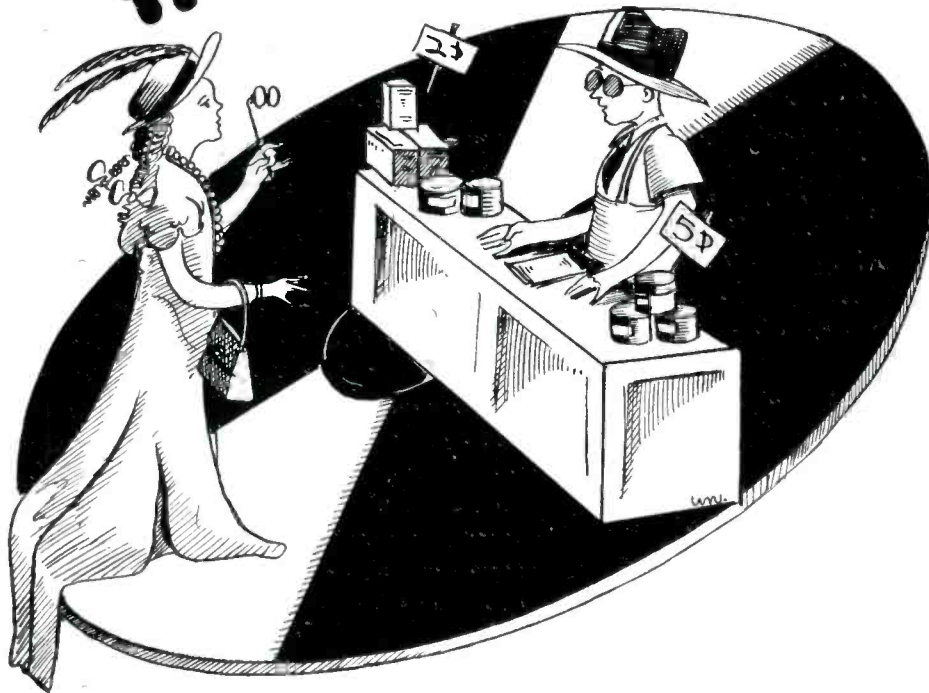

Puzzled? When we were kids that was our way of asking in code, "Have you any ham and eggs?" Read it quickly and see if it doesn't sound that way. Every so often, even at this advanced stage of life, we feel that we have to say it to someone . . . just for the hell of it.

But to get down to business, of course we don't have ham and eggs. We make Advance Recording Blanks . . . mighty fine blanks, at that. Studio engineers with leading networks throughout the nation proclaim their excellence because they contain the five qualities most desirable for transcription. (1) They're flat; (2) there is no trouble with treads (threads not statically charged); (3) no surface noise; (4) they reproduce clearly; and (5) they have long playing life. If you've already tried them, we're sure you've reordered them. If you haven't, Y. N. L. don't you write today for a trial order of superior Advance Recording Blanks.

*U. L. F. Plenty of M. N. X.
in ten years, if you invest
in War Bonds today, and
keep them until maturity.*

Advance
Recording Products
Company

36-12 34th STREET • Stillwell 4-7837 • LONG ISLAND CITY, N. Y.

Broadcast Engineers' **5** Journal - August, 1944

Crystals

FOR THE CRITICAL

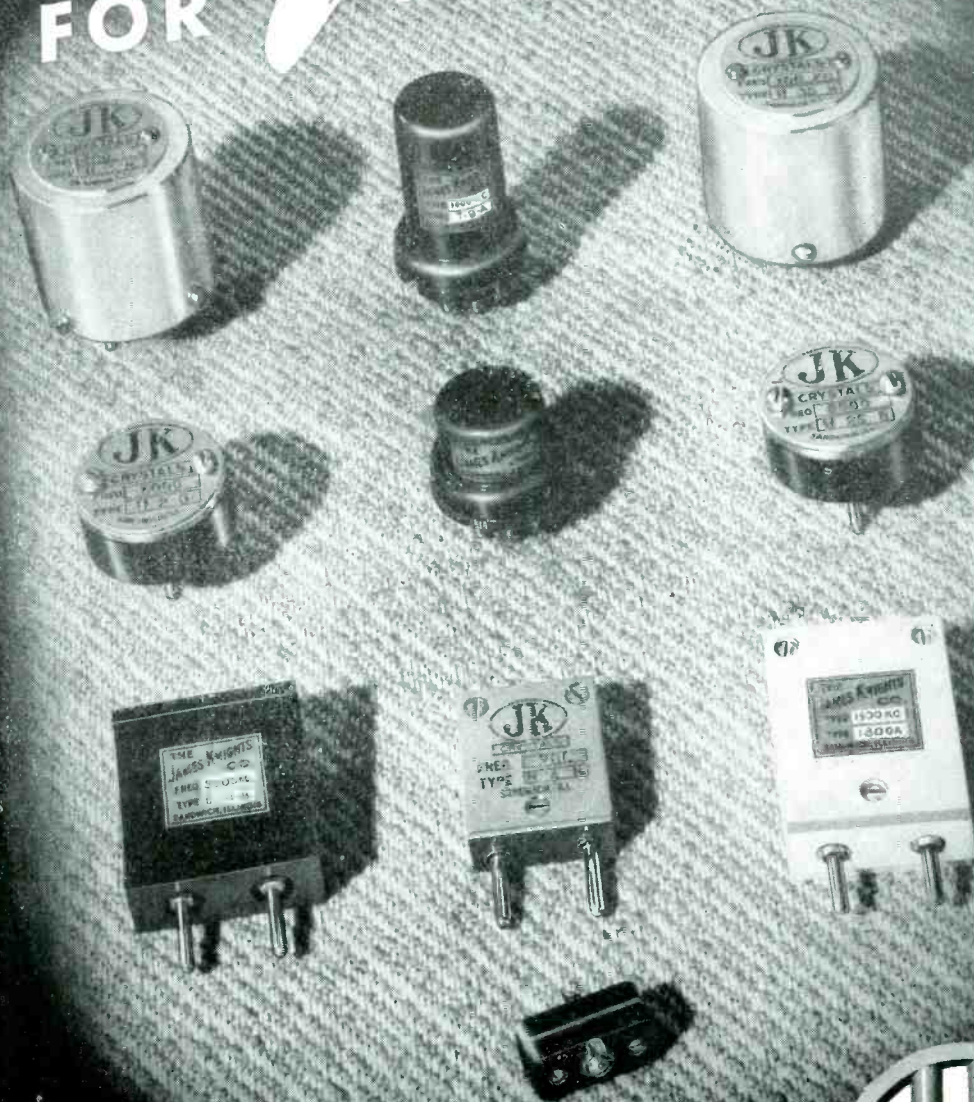

The **JAMES KNIGHTS Co.**
SANDWICH, ILLINOIS



The 6J4 Grounded-Grid U-H-F Triode

The 6J4 is a heater-cathode type of miniature triode for use primarily as a grounded-grid u-h-f amplifier at frequencies up to approximately 500 megacycles. Its design features an amplification factor of 55 combined with an extremely high transconductance of 12000 micromhos, and permits grounded-grid operation with a high signal-to-noise ratio. The 6J4 may also be used in conventional triode circuits with ungrounded grid.

In grounded-grid service, the grid of the 6J4 functions as a shield between cathode and plate, and the input-signal is applied to the cathode. The input circuit, therefore, is between cathode and the grounded grid; and the output circuit is between plate and the grounded grid. To keep the capacitance low between cathode and plate, and thus reduce undesirable feed-back effects, use is made of internal shielding connected to the grid. The grid is provided with three terminals for effective grounding with the minimum of reactance.

The miniature construction employed for the 6J4 permits short internal leads with low inductance—a feature of primary importance in u-h-f operation—and results

in relatively low cathode-grid and plate-grid capacitances for a tube having such a high value of transconductance.

General

Heater Voltage (A.C. or D.C.).....	6.3	Volts
Heater Current	0.4	Ampere
Direct Interelectrode Capacitances:*		
Plate to Cathode & Heater [Cp(k+h)]	0.24 max.	mmf.
Grid to Cathode & Heater [Cg(k+h)]	5.5	mmf.
Grid to Plate [Cgp].....	4	mmf.
Heater to Cathode [Chk].....	2.8	mmf.
Maximum Overall Length.....	2 1/8"	
Maximum Seated Height.....	1 7/8"	
Maximum Diameter	3/4"	
Bulb	T-5 1/2	
Base †	Miniature Button 7-Pin	
Mounting Position	Any	
<i>Maximum Ratings Are Design-Center Values</i>		

Maximum Ratings and Typical Operating Conditions

Plate Voltage	150 max.	Volts
Plate Dissipation	2.25 max.	Watts
Plate Current	20 max.	Milliamperes
D-C Heater-Cathode Potential....	90 max.	Volts

Typical Operation and Characteristics — Grounded-Grid Class A₁ Amplifier:

Plate Voltage	100	150	Volts
Cathode-Bias Resistor (suitably by-passed)....	100	100	Ohms
Amplification Factor	55	55	
Plate Resistance	5000	4500	Ohms
Transconductance	11000	12000	Micromhos
Plate Current	10	15	Milliamperes

Installation and Application

The base of the 6J4 fits a button-base socket which may be installed to hold the tube in any position. For grounded-grid operation, all three grid terminals should be grounded to minimize the effects of grid-lead inductance on u-h-f performance.

The 6J4 should be operated so that its *design-center maximum ratings* will not be exceeded if most satisfactory performance and life are to be obtained.

In arranging the circuit for the 6J4 used as a grounded-grid r-f amplifier or mixer, it is preferable to have the heater operate at the same r-f potential as the cathode,

(Continued on Page Eight)

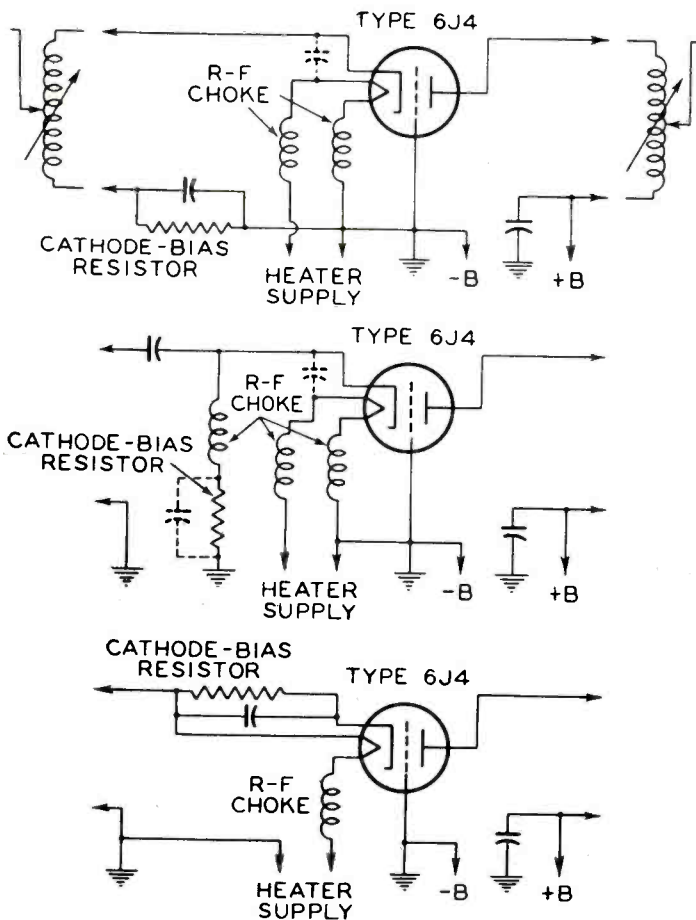

New C-R-O Facilitates Recurrent and Transient Studies

To facilitate the investigation of transient as well as recurrent phenomena over a wide frequency range, Allen B. DuMont Laboratories, Inc., Passaic, N. J., announce their new Type 247 Oscillograph.

This instrument utilizes the new Army-Navy preferred Type 5CP1 cathode-ray tube with intensifier electrode, operated at an overall accelerating potential of 3000 v. High-intensity patterns are obtained on the 5" diameter screen. The medium persistence green screen is standard. If a permanent record of transient phenomena is required, the instrument may be supplied with short-persistence blue screen for high-speed photographic recording, or with the long-persistence green screen for visual observation of low-speed phenomena.

The sweep frequency range has been extended down to one-half cycle per second providing a wider range of sweep operation. Thus it may be used for observations on low-speed machinery and for other low-frequency functions. The time-base provides recurrent, single or repetitive sweep operation. An unusual beam control circuit is used with single sweep operation, to darken the screen except during the actual sweep cycle, providing a reduction of background illumination and resulting in photographs of greater contrast. Exceptionally uniform response over a very wide frequency range for both the vertical and horizontal axes; a distortionless, continuously-variable low-impedance attenuator or gain control; a Z amplifier channel for applying external timing signal to the grid of the modulating electrode; and other features and refinements, mark this instrument. Dimensions: 14" w., 19" h., 26" d. Weight 130 lbs.

Other pertinent data: Vertical amplitude response does not fall below the uniform value more than 10 per cent from 2 to 200,000 cps, and is down approximately 50 per cent at 650,000 cps. Phase response is said to be linear. Vertical deflection direct to plates is 20 volts rms per inch; with maximum vertical amplifier gain, 0.05 volts rms per inch. The input circuit consists of a 2 meg resistor and 30 mmf shunt capacity (effective).

The horizontal amplifier is reasonably uniform to 100,000



operated at an overall accelerating potential of 3000 v. High-intensity patterns are obtained on the 5" diameter screen. The medium persistence green screen is standard. If a permanent record of transient phenomena is required, the instrument may be supplied with short-persistence blue screen for high-speed photographic recording,

6J4 U-H-F TRIODE

(Continued from Page Seven)

so that the cathode-heater capacitance will not be added across the input-circuit capacitance. Placing r-f chokes in series with the heater leads is suggested as a suitable method of operating heater and cathode at the same r-f potential.

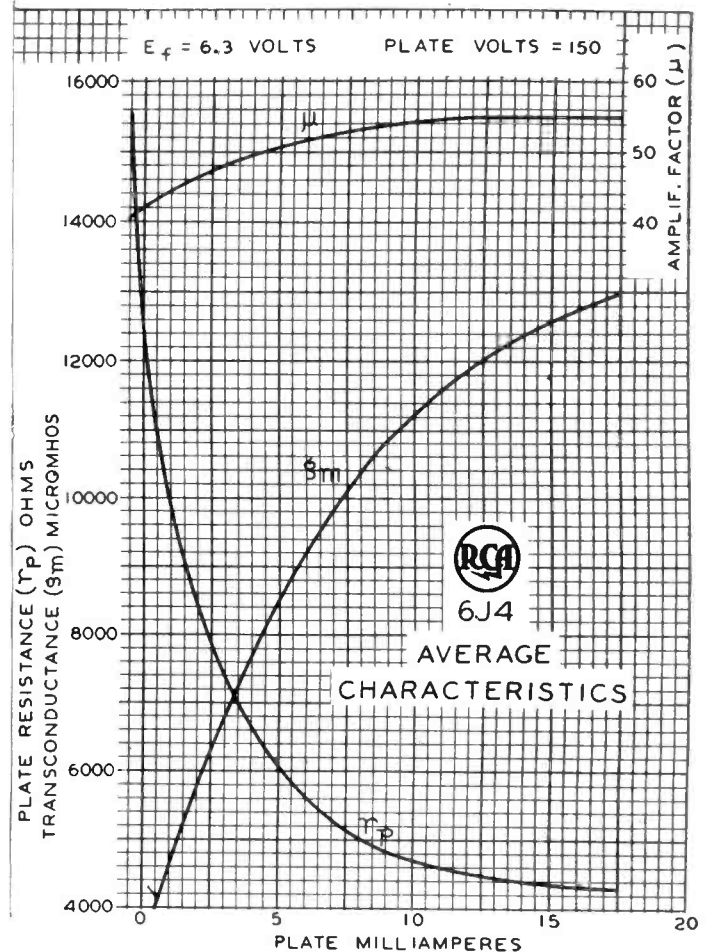

* With close-fitting shield connected to grid.
NOTE: The 6J4 should always be used with a cathode-bias resistor suitably by-passed. The d-c resistance in the grid circuit should be limited to 0.25 megohm.

† The center hole in sockets for this base provides for the possibility that this tube type may be manufactured with the exhaust-tube tip at the base end. For this reason, it is recommended that in equipment employing this tube type, no material be permitted to obstruct the socket hole.

(Data courtesy of RCA Victor Division, Harrison, N. J.)

cps (sine wave).

Z-Axis amplifier is provided to permit the application of an external signal to the grid of the Cathode-Ray tube. Such a signal can be used either to blank out or to intensify the beam in accordance with the amplitude variations of the signal. An input signal of 2 volts will provide adequate beam blanking at normal beam intensity. Sine-wave response of the Z-amplifier is 50 cycles to 2 mc.

Elemental Electronics

Part VIII — Peaking Circuits

By Jordan McQuay

PEAKED wave shapes have a wide use in electronic circuits. Since such non-sinusoidal waves provide brief, almost-instantaneous surges of energy and can be timed to occur with split-micro-second precision, they have considerable use as triggering devices.

Peaked waves are also considered an "intermediate step" in the transformation of a sinusoidal or square wave into a rectangular or pulse wave shape. For this reason, a thorough understanding of the methods of producing peaked waves is essential to the later understanding of certain square, rectangular and pulse wave shapes which will be discussed in Parts IX and X to follow in future issues of this journal.

Peaked waves can be formed by any one of three general methods. When a square wave of voltage is applied to a simple RC network, having a short time constant, the output will be peaked wave of voltage. When a sine wave of current is applied to a circuit containing a special type of inductance which saturates at a low value of current, the result will be a peaked wave of current. And when a square wave of voltage is applied to the primary coil of a loosely-coupled transformer, there will be a peaked wave of voltage across the secondary.

Each of these "peaking" methods will now be considered.

A peaked wave is usually obtained by utilizing the distortion properties of a resistor and condenser, connected as shown in figure 1. It will be remembered from Part II of this Series (*B. E. Journal*, Febr. 1944), that the time constant of a circuit containing resistance and capacitance is equal to the product of RC, in seconds. Referring to figure 1, if this RC product is smaller than the time of one-half-cycle of the input square wave, the circuit is said to have a short time constant. When the square wave voltage E is applied to such a circuit, the condenser C charges as shown by the E_c voltage graph (figure 1). And the resultant or output voltage E_R , taken across the load resistor R , will have a decidedly peaked wave shape.

The slope of the trailing edge of this wave shape may be altered by varying the value of either the condenser or resistor—keeping in mind that the product of R and C must be considerably smaller than the time required for the impressed square wave of voltage to complete a half cycle. The output voltage E_R can have almost any peaked shape

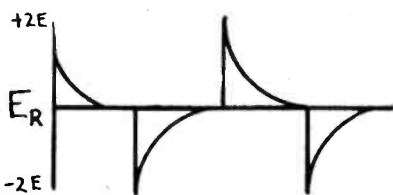
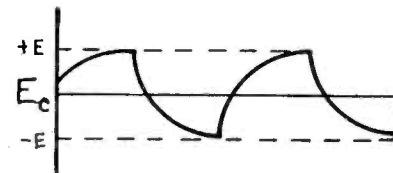
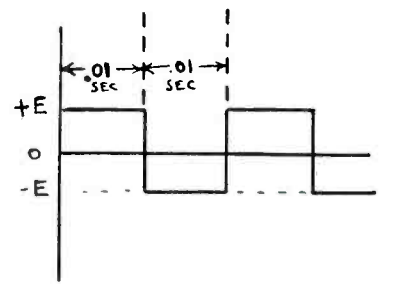
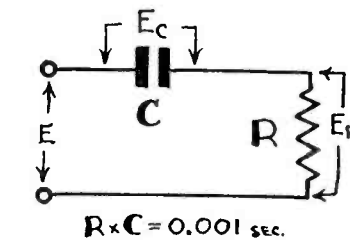

Figure 1 — Formation of Peaked Waves using an RC circuit with a short time constant.



desired, and the maximum (peak) value of such a distorted wave will be actually *twice* the maximum input voltage, or $2E$. This is due to the sudden charge and discharge of the condenser, as discussed in Part II of this Series.

Short time-constant RC circuits can only be used to produce peaked waves when the input voltage is in the form of a square or rectangular wave. And this is the most popular method of obtaining peaked voltage waves, since the circuit does not depend directly upon a large number of critical components, or vacuum tubes.

Peaked waves may also be obtained by applying a sine wave of current to a special coil having high inductance and using relatively low current. Such a peaking circuit is shown in figure 2, where L represents the special type of inductance. This coil gives minimum inductance for any high current value. It thus effectively bypasses the signal so that no current passes through the resistor R . When the current is nearly zero the inductance of the coil increases to maximum and the coil produces short voltage impulses, first positive then negative. This charges the condenser C to a voltage equal to the pulses from the inductance. The current used to charge condenser C passes back and forth through

Elemental Electronics

the load resistor R , and the output is in the form of a peaked wave shape.

A third method of obtaining a peaked wave form is by the use of a loosely-coupled transformer. A square wave of voltage applied to the circuit shown in figure 3 will produce a peaked wave of voltage across the secondary, due to

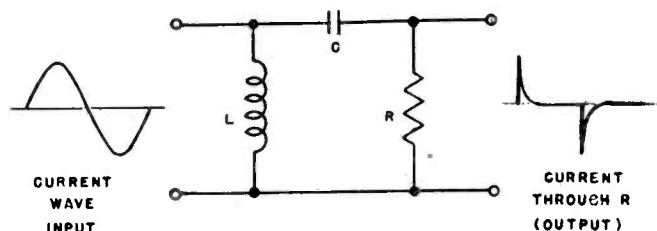

Figure 2—Formation of peaked waves using a special type of inductance.

transformer action. Since the voltage changes in a square or rectangular wave are abrupt, and the voltage then maintains a steady value for a comparatively long time,—the transformer will produce an output voltage *only* during the short periods when the square wave of voltage is undergoing an abrupt change. Typical voltage wave forms are shown in figure 3, the peaked wave output resulting from this characteristic transformer action. The primary and secondary coils of the transformer are usually coupled rather loosely—to reduce unwanted inductive effects due to mutual inductance, and other factors. The secondary coil of such an arrangement would ordinarily tend to oscillate, when struck by such sudden pulses, but this is largely overcome by placing a resistor R across the secondary winding (figure 3) which acts to effectively “damp out” undesirable oscillations of this nature.

Of the three methods of peaking discussed, the CR circuit with a short time constant is probably the most universally employed in electronic circuits.

The values of capacitance used in any peaking circuit are probably the most critical components. For this reason,

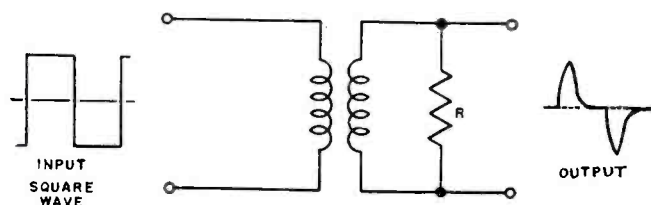

Figure 3—Formation of peaked waves using a loosely-coupled transformer.

such condensers are usually, but not always, fixed in value—and changes in the circuit made by varying some other component: the resistance, or inductance. Peaking circuits are easily adjusted and, except in certain television applications involving wave shapes, and relatively simple in operation.

H. Sadenwater Named Eastern RCA Broadcast Sales Manager

The appointment of Harry Sadenwater, one of the pioneers in radio's history, as broadcast equipment sales manager for RCA in the Eastern region was announced today by T. A. Smith, Standard Radio and Sound Equipment Sales Manager and M. F. Blakeslee, Eastern Regional Manager.

Mr. Sadenwater, who will headquarter at the RCA sales offices at 411 Fifth Avenue, New York City, will be responsible for the sale of broadcast transmitters and associated equipment to eastern radio stations. He brings to his new position exceptionally wide experience in installation and operation of many types of radio communications equipment. Prior to his present appointment he was manager of services for RCA Laboratories at Princeton, N. J.

Known to broadcast engineers throughout the country, Mr. Sadenwater has participated in many important events of communications history during his thirty years of association with “wireless” and radio.

A naval lieutenant in 1919, he became nationally known as the radio officer of the famous NC 1, one of the four Navy flying boats that made the first trans-oceanic flight from the U. S. to Europe. In the same year he engineered the first long distance, radio-telephone tests, transmitted from a plane flying over Chesapeake Bay and Potomac River to the then Navy Secretary Josephus Daniels in Washington, D. C. During World War I he was radio procurement officer and censor for the Navy.

Mr. Sadenwater has been active in radio since its earliest days, and in 1914 he became an associate member of the Institute of Radio Engineers. In 1915 he obtained the first extra grade commercial operator's license and prior to entering the Navy in 1917 acted as U. S. Radio Inspector for the Department of Commerce in the Port of New York.

Following the war he joined the General Electric Company and became widely known as a broadcast engineer during the early days of broadcasting. In 1923 as engineer in charge of technical operation of broadcasting stations, he built the West Coast Station KGO at Oakland, Calif., and a year later built Denver's KOA.

In the operational field, Mr. Sadenwater is remembered for his work with the early networks in which he tied WGY to WJZ (New York) and Syracuse, Rochester and Buffalo stations over telegraph lines. He conducted early experiments with shortwave program circuits to Denver and Oakland. Other pioneer achievements were operation of the first crystal controlled station, the first 50, 100 and 200 kw stations at South Schenectady's experimental high power station and the famous W2XAF Schenectady shortwave stations.

In 1930, Mr. Sadenwater transferred to RCA Victor at Camden, N. J. Here his experience was utilized in the development of such equipment as the first ultra-high frequency walkie-talkies, first ultra-high frequency aviation equipment and development of special receivers for the Navy. He also directed the installation of the first 500 kw commercial transmitter for Cincinnati's Station WLW. From 1939 to 1941, when he became manager of service at RCA Laboratories, Mr. Sadenwater was a television project engineer.

He is a member of the Institute of Radio Engineers, the Army and Navy Club of Washington, D. C., and the Radio Club of America.



WHAT WE'VE BEEN THROUGH!

1251200 TINNISWOOD. B. SGT.
ROYAL AIR FORCE.
P.R. (O) UNIT.
BNAP.
24/9/43.

DEAR SIRS, During a few quiet spare moments out here on the latest battle front, I thought that perhaps you would care to know the history of one of your model 8-F Recording Machines. Just what it has been through, just what it has done for thousands, perhaps millions of people all over the world, and just what it is doing at the present moment.

It was available in Cairo over two years ago, and the RAF purchased it for the Mobile Recording Unit for work on the front, recording everything and anything that would be interesting to the public of the world. I am the engineer that has had the pleasure of operating this machine all this time, and being in the radio trade for fourteen years, should know when a set is well made or not.

It has travelled over 23,000 miles. Approximately 20,000 by road, track, or desert, in one of the hardest sprung trucks of the British Army, and 3,000 by air. It has recorded bomb and shell explosion in slit trenches, covered with dust. Blown over on one occasion by blast. Dropped on numerous occasions. Has recorded in the air, and on sea rescue craft, with better results than expected.

2

Has travelled to: Amman Transjordan, to Tripoli, back to Cairo, back to Tripoli, on to Tunis, Bizerte, on to Algiers, back to Tunis, on to Sicily, all through Sicily, on to Italy. All this way by truck, recording, re-recording, about, has it let our little party down. Never in my opinion, has any radio apparatus stood up so well, for so long in such conditions. Recordings from this machine have been broadcast from the following countries: England; America; Canada; New Zealand; Australia; Sth Africa; Egypt; Palestine; Algeria. Perhaps presently, from Italy itself. Please thank your engineers and assembly workers for such an efficient and trouble free recorder, and may you continue to put such products on the market.

If you care to acknowledge this letter please address to my home in England, 110 Cardinal Avenue, Morden Park, Morden, Surrey, GB.

Yours truly,

B R Tinniswood

To: The Managing Director,
Presto Recording Corp.,
242 W. 55th St., New York; U.S.A.



Presto Recording Corporation, New York 19, N.Y., U.S.A.
World's Largest Manufacturers of Instantaneous Sound Recording Equipment and Discs
Walter P. Downs, Ltd. in Canada

from . . . HOLLYWOOD . . . By Norman Dewes

BLUE contract approved . . . 5% gets closer . . . Melrose sold . . . Jensen a papa . . . mixers' guild formed . . . new Councilmen . . . fish . . . Television . . . a few tans . . . weather mostly unreportable . . .

WE'RE going to occupy most of our space this month with gossip, in order to catch up on Happenings in Holly Woods . . . so bend an ear to the dirt . . . BUT FIRST . . .

ANOTHER chapter in the history of the old Melrose studios is nearly written . . . with the sale of the building by Consolidated Film Laboratories to RKO Pictures for rumored use as a television plant. Colorful has been the story of the building which arose from the ashes of one of the largest fires in Hollywood, that of the Old Consolidated Lab years ago. NBC Hlyd graduated from a single sound stage studio on the RKO lot to fine new ones in the re-built building in 1935 . . . many of radio's biggest shows and brightest stars began their careers there . . . and many of us will recall those pleasant though hectic days . . . then grander, roomier Radio City was built and Melrose was abandoned, except for occasional overflow use. KHJ/Mutual took over in 1940 and centered their West Coast activities there, but now they too must seek new quarters, at the end of their present lease. Rapidly grows the child of Wireless . . . and the old things continually pass under the bridge of Time . . .

NEWS . . . council elections are over and the CHOSEN ONES are Ed. Miller, Studio/Field Group; Craig Pickett, Master Control; Jim Thornbury, Recording; Bill Comegys, Maintenance; Thor La Croix, BLUE; and Ray Moore, KFI/KECA. First meeting of the new potentates was held at the Ray Moore estate, where Ray put on a VERY convincing television show, together with refreshments.

Field Super Joe Kay and ass't Hal Platt back and resting up from a ROUGH RIDE to Grand Canyon to cover the rescue of the Army fliers stranded on the bottom. Had many exciting experiences! Time was a factor, Joe chalking up 96 and one-half hours for the week, logging 23 hours one day and 21 the next, Hal bringing up the REAR.

Motorcycling being took up by quite a few of the boys . . . Johnny Morris, Maint Super already has one, and Pickett, Cooley and Thornbury have deals on for some released Army GO-BANGS . . . a sound investment, for you can go simply miles on a "D" coupon . . . making with the weeks per gallon instead of gallons per week.

STATISTICS . . . Robert Roderick Jensen, our genial Chapter Chairman, a VERY proud papa (see program) . . . Stevie Jensen now has a sister, this being TWO for Bob.

Johnny Eilers, BLUE, hitched on July 3rd, followed by the FOURTH . . . lucky girl is Hazel Woodle, at quiet private wedding and thence to Santa Barbera for a brief honeymoon. This is TAKE TWO for Eilers, who sez to

SECOND PRODUCTION OF THE SEASON
THE JENSEN THEATRE

presents

"It Did Happen Here"

An Old-fashioned Melodrama of Family Life,
starring its newest member,

Cynthia Ann Jensen

(weight, 7 lbs., 9½ ozs.)

ON JUNE 15, 1944, at 12:05 P.M.

North Hollywood, California

CHARACTERS

Mother.....Jan Dawson Jensen
Father.....Robert Roderick Jensen
Son.....Stephen Alan Jensen
BABY DAUGHTER.....CYNTHIA ANN JENSEN

The action occurs in the present time at St. Joseph's Hospital,
Burbank, California.

The setting, sunshine, roses, oranges, palm trees, etc., have
been designed and copyrighted by the California
Chamber of Commerce.

Coffee will be served in the Foyer to all fathers during the
intermission.

Costumes worn by CYNTHIA ANN JENSEN,
courtesy of Dy-dee Wash.

Exclusive photographic rights reserved by
Jencinema Productions, Inc.

The Management guarantees there will be no repeat
performance during the year 1944.

OK this one . . .

BLUE . . . Helen on vacation and Denny knee deep in DETAILS . . . phone calls, schedules, blueprints, train tickets, ETC. all over the place . . . sez it's a one-man job just to keep track of Ragsdale . . . our K. O. Doty still dining with the stars at RKO, but NOT at the same table, DARN it all . . . Scramby-Amby and Blondie over to the Blue, with many others in the offing . . . Banks smelling sweet from daily exposals to P. & G. show . . . Powell around and about on Sardis' safaris . . . Baxter reading up on chess and SMALL WONDER . . . Lorenz deep in fishing plans . . . La Croix Blue councilman again . . . Heffernan saying nothing and collecting his check, a SMART man . . . Clete Roberts, Blue war correspondent back from South Pacific and on his way thru to help cover Democratic Convention . . . looking mighty natty in his uniform . . . Walter Winchell out here for several weeks with all



New Councilmen—Hollywood Chapter N.A.B.E.T. Front row, left to right: **Craig Pickett**, Master Control; **Jim Thornbury**, Recording; **Charles Young**, KFI/KECA Group; **Thor La Croix**, Blue. Back row, left to right: **Eddie Miller**, Studio/Field; **Ross Miller**, Sec'y-Treasurer Hollywood Chapter; **Bob Jensen**, Chairman Hollywood Chapter; **Lew Winkler**, Alternate, Maintenance Group; **Ray Moore**, Chairman, KFI/KECA Group.

his paraphernalia, providing CODE practice for the boys before the show . . . he sends it in inverted Sanscrit cryptographs, just to make sure you don't cheat . . . nice fellow, Walter, altho he hasn't asked US for any lowdown yet . . . a rumor going about that the BLUE contract has been RATIFIED by the WLB . . . we can almost TASTE that 5 per cent, huh fellows? Leave us not hold our breath, altho something ELSE might be in order . . .

CHIPS . . . **Bill Moyer** back in town from Seattle . . . in defense work . . . **Honest John DeGrazzio** fixing to build a Game Farm . . . (free room and board, if you're GAME) . . . **De** leaving for two weeks' rest, after dizzy round of parties to launch his two oldest dahters into matrimony . . . **Raoul Murphy** a full-fledged studio man now . . . **Sil Caranchini**, Recording Super wearing an uplift (not THERE) . . . due to throwing some muscles in the rear out of gear . . . just ask him about chiropractors . . . **Sil** has new secretary named **Evelyn Raft**, replacing **Bobby Boardeman** who is leaving for Broadway, N. Y., and the theatah . . . we wish them BOTH lots of luck . . . **McWhinney**, Rec. going in for photography . . . art stuff . . . and out in hills making a set-up and suddenly SHOTS start coming over . . . **Mac** and subject dive for fox holes, finding that they are on the Sheriffs' Practice Range . . . **Wetteland**, MCD, painting house while fambly on vac in Portland . . . **Art Brearley** busy tutoring embryonic engineers in Radio Institute summer school, with **Oscar Wick**, Maint, as assistant prof . . . the trouble is, the BELL rings and **Oscar's STILL TALKIN'** . . . **Fry** to barebecue steak fry at **Andy Devine's** valley rancho . . . **Harry Bryant** and wife on vacation . . . he to South Carolina and she to North Dakota . . . visiting respective folks . . . **Eddie Miller**, SE back from annual vacation fishing trip with pics of fine catches of rainbow trout, some more than THAT long . . . not enuf gas to get up

to High Sierras this year, so had to be content with a few twenty inches from Big Bear . . . **Lorenz**, sez yeah, but wait until I get back from MY trip and you'll see some FISH . . . new swank eatery on the Boulevard . . . lush red Russian leather appointed booths, brilliant chrome and flashing mirrors, music and beautiful girls to take your order for the Chef's Special and ONLY dish, HOT DAWGS . . . with or without chili and onions . . . BCNU . . .



Eddie Miller, NBC SE, and his annual catch of fish.

From SAN FRANCISCO

By S. A. Melnicoe, K. Martin, A. Wauchope

BIGGEST news of the month here is the party which the San Francisco Chapter threw for Lieutenant Commander E. Callahan on the eve of his departure for Chicago. Everybody that wasn't on watch gathered at Lucca's for what all agreed was one of the best evenings of the year. Tom "Senator" Watson started the abdication speech three times but was shouted down by Guy "Skeets" Cassidy who told 'em plain and fancy. Charlie "you tell



The Start of Things at Dixon

NBC, OWI, and DPC officials visited the Dixon plant. Among them were John W. Elwood, center, Manager KPO-NBC; Charles Pease, Chief Engineer, Pacific Division Bureau of Communication Facilities, OWI; right standing, Carl G. Dietsch, NBC engineer-in-charge of Dixon plant; and George Greaves, chief engineer KPO, both kneeling lower right.

"m" Kilgore again demonstrated that famous capacity. Among those present was Lieut. Bob Brooke who learned a few more things about Navy life from "Cal". After this one was over the boys here started planning the one that will take place when the boys all get back.

Speaking of fellows in the service, Commander P. A. Sugg, Lieutenant Commander Frank Fullaway, both ex-supervisors at San Francisco, and Warrant Officer Howard Crissey, ex-NBC Chicago, were all recent visitors.

Add to TOJO's worries: the armor plate has been removed from the control rooms and the plate glass substituted, a sure sign that the navy is closing in on Japan, hi. We were really glad to see it go. The place is being redecorated with the new color scheme very eye-resting. So are the glimpses of the Blue network's feminine contingent passing in review; something we've been missing for lo, these many (2) years.

Another colorful eyeful is added to San Francisco's Radio City these days by the coeds attending school in the NBC-Stanford Radio Institute. ME Don "we fix 'em"

Hall is again their mentor in control room techniques. Don says a certain percent of the questions they ask are intelligent but won't say what percent.

Dick Parks, formerly KGO transmitter, writes from Long Beach that it's Major Parks now. Congratulations—nice going.

Vacations find J. Alan O'Neill, Recording Supervisor, returning from a sunny stay near Carmel; "Skeets" Cassidy, SE, with a fine tan acquired at his Palo Alto Rancho; Oscar Berg, Maintenance Supervisor, smiling and happy because of an unexpected furlough vacation with his marine son; Shorty Evans, Chief KGO, retiring to his Hayward ranch and a thought of following those nags south; Ed Manning, KPO TE, wondering what to do about it. Our guess is that Ed's receiver gets another going over. The only original part left on the chassis is the tuning dial and condenser.

Gardening seems to be the major activity and subject of discussion at KPO. Art Dingle, TE, using the lot next door and with the expert help of janitor Wright, has artichokes growing all over the place, even in the strawberries. Made life miserable for Mrs. Dingle during his vacation by painting. She's the one that has to get it off the floors and windows. Ralph Stubbe, TE, has added three milch goats to his rabbits, chickens, turkeys, and ducks. Andy Wauchope, TE, has added a new perpetual motion idea to his garden. He has acquired a duck which lives on the



KGO Engineer Vernon L. Harvey monitoring a pickup of newscaster Tony Morse in the Bond Sales window of the City of Paris in San Francisco. Pickups were made twice daily from this point during the Fifth War Loan Drive.

snails and dispenses fertilizer for the garden at the same time. Seems to be taking a hint from E. E. "youse guys get the overtime" Jefferson. Jeff is now trying to find a

(Continued on Page Fifteen)

KFI - KECA NEWS . *By Ernest F. Wilmshurst*

VACATIONS et cetera have kept us out of print for a couple of issues, so we will have to think back for our information.

Looking over personnel changes, we find that **Robert Cook** (our former local Chairman) has resigned to return to his former place of employ with the Walt Disney Studios. A most pleasant and efficient person. A definite Disney gain. And speaking of gains we have ballotted **Raymond Moore** into the vacated Chairman post. **Rex Bettis**, tall, torrid and taciturn, takes over the secretarial job from **Ed. Starr**. One man has been added to our studio staff, he's a Darling and his first name is Ted. Mr. **Darling** comes from a former lab job. We hear that **Patterson** ex-KFI is now a senior "leftenant" and is in the South Pacific. He now matches **Norm Leonard**, who is also in the South Pacific.

Having just returned from vacation, I haven't much else in the way of fresh news. You know, of course, that the **George Hicks (Blue) Network** has acquired the KECA transmitter, subject to FCC approval of sale, and they, the Blue, expect to take over the operation of the station about September 1st. Both KFI and KECA are still living in the same building but it is rumored that KFI stays up all night.

KFI transmitter lost it's two thorobred police dogs but they were found and returned four days later. The dogs "Sig and Vicky" can't be reached for a statement at this time. **Lyman Packard** says they tunnelled under the fence

and beat it. He apologizes for their dereliction of duty explaining that they are boy-dogs and that we have had a very late spring. He was hurt, however, by their theft of two red ration points. Both dogs, while a bit hang-dog in expression, have a look of wondrous enlightenment in their baggy-eyes.

Pop Everett, morning supervisor, is breaking out his outboard racer and has turned up with eight gallons of super-racing fuel (alcohol and ether) . . . he is also on a bland diet of baby food to escape a threat of ulcers . . . we choose to see no connection between the large alcohol supply and his diet. Pop laughed heartily when we broached the subject.

I called my Spanish correspondent Sr. **Jose Sahara** on the order wire, asking for news from KECA transmitter. He is going to call me back. So here is the KECA news . . . "He didn't call."

We will try to have a bit of news re KECA and Blue next issue. If NBC will sell WEAF's original 8A studio, amplifier (with complete set of non-microphonic tubes) then KECA's future will be assured. The famous 8A used to save many a day on Broad Street, N. Y., and Sutter St., SF, and so why can't it save Hollywood. If Hollywood is worth saving. Incidentally to you easterners, I would like to make it clear that Hollywood is a small suburb of the City of Los Angeles and not vice versa. There are no movie studios in Hollywood that I can think of. It used to be a beautiful place covered with oranges and lemons but now the oranges come from East Los Angeles.

SAN FRANCISCO

(Continued from
Page Fourteen)

market for the overproduction of his young truck farm on the side of Twin Peaks.

George Irwin, KGO TE, has become an expert on outdoor furniture, getting his knowledge the hard way. Claims he uses nothing but scrap material, too. Maybe a NABET outdoor meetings is in order now that George has the furniture.

At KGO these days they don't talk automobiles to **Jim Ball**. Seems that the faithful Chevy which hasn't acted up in years was finally overhauled. THEN it started to act up just when Jim was leaving for home. Mr. Ball—such language!!

Bryan "Duke" **Fuhrman**, SE, joins the NBC group at SF. Got a ride to Sebastopol with **George McElwain**, Field Supervisor, on a field pickup, the first week he was here. Welcome to the gang, Duke. Understand he was formerly a radio instructor for the army. He was initiated by **Tobe Hamma**, Blue SE, who ate Fuhrman's lunch and then,

lawyer-like, tried to talk his way out of it. P. S.—**Hamma** then furnished Duke's lunch.

Outside pickups seems to be the order of the day for the studio Blue group. **W. Andresen**, FE, and **Clark Sanders**, FE, off on Coca-Cola and Town Meeting treks. **Sid Blank**, **Vern Harvey**, **Mark Dunnigan**, and **J. McDonnell** all out covering pickups at the Claremont, City of Paris, Emporium, Bal Tabarin, etc., with **Tobe Hamma** covering specials.

Picture of something or other—**Frank "Standard Oil" Barron**, cranking gain on a 1500 voice chorus singing Anchors Aweigh with **Edwin McArthur** covering up the whole thing with his "accordeen"—**Lee** "they grow 'em big in Oregon" **Kolm**, at MCD, wondering what was happening to **Frank**. **Bob** "we cut what comes in" **Shover** saying, "It's all on the disc".

As we write this **Parkhurst**, Relief Supervisor, **Hall** ME, and **Hamma** SE, together with a crew of producers and announcers are off to cover a big ammunition ship blast at Port Chicago. The university seismograph recorded it as a small earthquake. CUL.

NEW YORK NEWS

By George F. Anderson, Jr.

IN A "V" letter from London, **Bob Massell** tells us that he is up and around and completely recovered from his recent illness. He is rather unhappy that he missed the recent "D"-Day doings in England and the Continent but is going to make up for it. Bob says that he will be back at work in a very short time.

Special announcement: July 1, 1944, Thomas M. McDonald, weighing in at eight pounds, said: "Hello Mom—Hello Pop," to **Beatrice** and **Gilbert McDonald**. Gil, a studio engineer for the Blue Network here in New York, is bearing up very well under the circumstances and is trying hard to act normal, but he seems to find it difficult to keep his feet on the floor.

On July 31, Michael James McCarthy, son of **James McCarthy**, ME-NBC, will celebrate his second birthday. It seems that everyone will tell how old their children are, but will only say that they are either over twenty-eight or look worried.

Arthur Popple, ME-NBC, **Al Weis**, FE-NBC, and **Tony Hutson**, FE-NBC, have come and gone again. They are back in Chicago again, this time for the Democratic

Convention. We have been asked to inquire of **Al Weis**, what the contents of the gift package was, that his friends in New York sent to him while he was in Chicago? Tsk-Tsk.

Frank Connelly, formerly ME-NBC, has been promoted to First Lieutenant AUS., and **Jimmy Coleman**, former SE-NBC, has been made a Captain in the USMC. Jimmy entered the Marines as a Staff Sergeant, went thru OCS, came out 2nd Looey—then first, and now while in the South Pacific has been made Captain.

Einar Johnson, ME-NBC, who has been with NBC for quite a few years, has now been transferred to a television assignment and will be a Group Twelve man.

Chuck Beardsley, Recording, supplies us with the following: Apprentices, New—**Ruth Ready**, from NBC sales Research. **Victoria Lazarek**—from the Navy Department, where she was engaged in radio work at New Orleans and Philadelphia. **William Fidler**, from WNLC, New London, where he was a Studio Engineer, Engineers—new—**Harold Schneider**, from Bethlehem Steel, where he was engaged in Radar and from CPS Recording, Staten Island, New York. **Noel Warwick**, formerly USN Radioman. **Ernest**

If you have not been using or have not yet tried Allied's New Glass Base Discs, a trial will convince you of their merits and superior quality — at no premium in the cost to you. We invite you to try this disc — that is how we obtain new customers. We feel certain that you will

reorder — that is how we build sales volume — from satisfied users. Your telephone call, letter, wire or cable will receive our prompt and courteous attention.

PROMPT DELIVERY direct from the manufacturer to any part of the United States, Canada, South America and to some foreign countries. ALSO AVAILABLE recoating service for your old aluminum discs. Delivery in one week. Details on request.

ALLIED RECORDING PRODUCTS CO.

21-09 43rd Avenue

Phone STillwell 4-2318
Cable: Allrecord New York

Long Island City, N. Y.

ALLIED GLASS BASE RECORDING DISCS

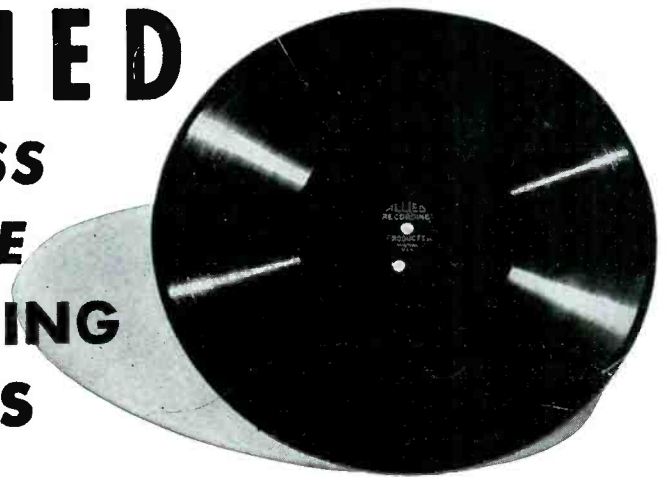

McDowell, of Press Wireless and Joseph Schmidlin from Philco. Engineers—from Apprentice to Group Two—Dave Plunket, who has been promoted after serving his apprenticeship. Fred Frutchey, who has been in London for NBC, writes that he recently made a tour of the BBC and that their new equipment is the "tops". Ed. Schabbegar, recording, is resting comfortably in the Rockville Center hospital, following an operation. He expects to go home shortly. Best Wishes Eddie from everyone for a speedy recovery and enjoy the summer vacation that you are having.

Lieut. Jg. Charles (Joey) Colledge, USNR, dropped in to see the boys and reported that he likes the Navy very much and that he has met quite a few former NBCits.

Well, that's Chimes for Now.

New Television Stations

From FCC Report No. 1581

E. F. Peffer, Stockton, Calif. Channel No. 3.

From FCC Report No. 1583

Bremer Broadcasting Corp., Newark, Channel No. 5.

From FCC Report No. 1584

J. E. Rodman, Fresno, Calif. Channel No. 2.

From FCC Report No. 1585

General Telev. Corp., Boston. Channel No. 1.

From FCC Report No. 1586

Westchester Broadcasting Corp., White Plains, N. Y.

Channel No. 13 (230-236 mc).

Philadelphia Inquirer, Philadelphia. Channel No. 6.

Dr. Ralph L. Power, Los Angeles radio counsellor, has returned to his own office. He became an inspector in the San Francisco Signal Corps Inspection Zone in 1942. Early in 1944 he was made an administrative inspector on a part time basis to return to his clients part time. Final termination came shortly after the invasion opened. He was resident inspector in charge of prime statite contracts for 18 months at one plant.



Dr. Ralph L. Power

He is a Companion of the Australian Institution of Radio Engineers and was once a co-director with Dr. Lee de Forest on the directors of the Los Angeles chapter of the American IRE.

His activities include editing Micro Topics bi-weekly for the Universal Microphone Co., his client since 1928; and the monthly Transmitter for the Hoffman Radio Corporation.

Dr. Power was one of the first radio announcers in Los Angeles and radio editor for the *Examiner*, *Times* and *Record* in succession. When mike spielers were given air names he was known as the "Sky Crier" but didn't like it, he says.

AEF veteran of World War I, and later a Legion Post Commander, he was in Australia when World War I broke out.

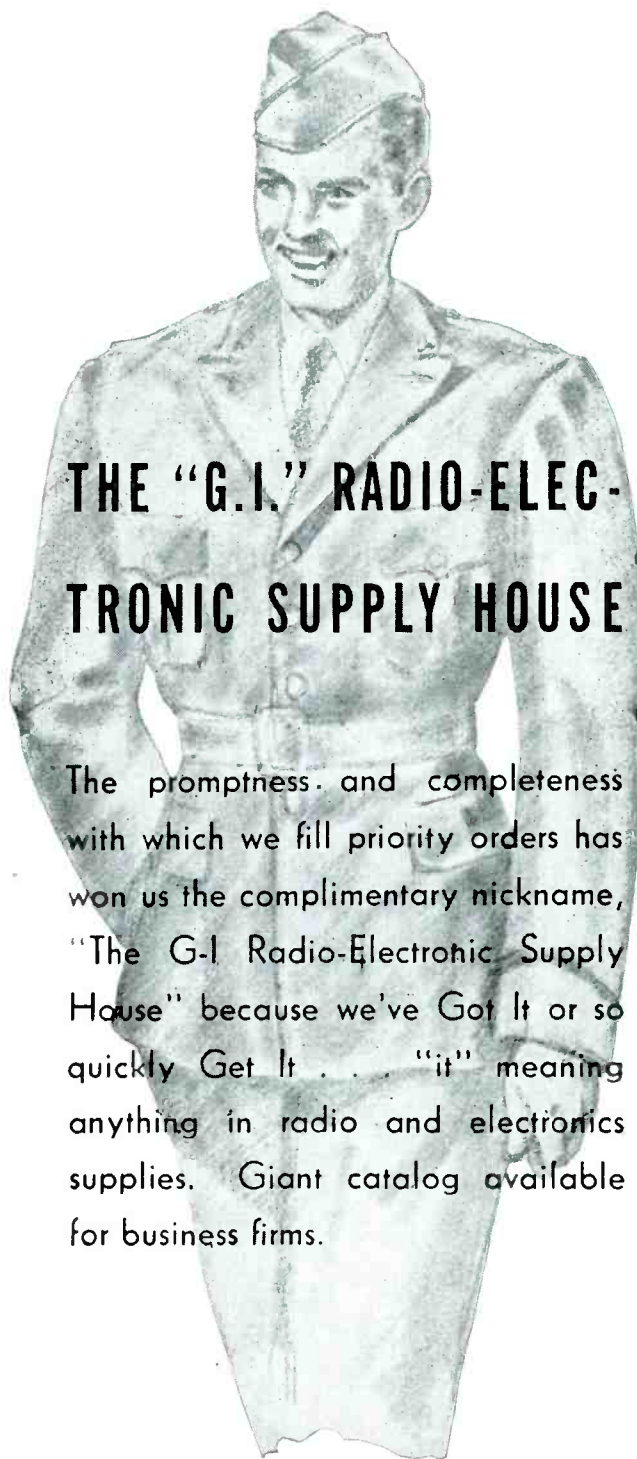

THE "G.I." RADIO-ELECTRONIC SUPPLY HOUSE

The promptness and completeness with which we fill priority orders has won us the complimentary nickname, "The G-I Radio-Electronic Supply House" because we've Got It or so quickly Get It . . . "it" meaning anything in radio and electronics supplies. Giant catalog available for business firms.

TERMINAL RADIO CORP.

85 CORTLANDT ST., NEW YORK 7, N. Y.

Phone WOrth 2-4415

Diary of a Plain Squirt Operator

By Homer A. Ray, Jr., of the WLW Transmitter Staff at Mason, Ohio

August 1

No sooner settled down this morning in my best operating position, when the day started with a ring. Don't take offense at the word because everything here at Mason, Ohio, is done with bells. We've even got a bell that tells when the water in the spray pond is too hard to run through the nozzels. Just last week Mr. Harry Lord, the latest addition to our staff, responded to a bell by picking up a fone out of which came the astounding words "ten point two". He was half way down to Tiny's Place before we caught him and explain—that it was not the Mason fone nor was ten point two a high octane version of three point two, but was the antenna current at the base of the tower. This particular ring this morning happened to be a postulant which necessitates pulling one's feet off the console and pushing the electric door lock.

August 8

Dog watch tonight. About one AM Petery walked up and announced "They have ghosts at WTAM".

"That's nothing, they have phantom circuits at WOW," and then I proceeded to explain that a phantom circuit is when you bridge about three hundred volts across a telephone line to operate a morse system (that's the way we do it here) and that this gives the telephone linemen a thrill when we dump half our substation in their laps high on a pole. We have no record of knocking any off poles but we sure bring out the best vocabularies in the union.

"Wonder what this Pruitt looks like. I hear he's afraid to put his picture in anything that finds circulation in Cleveland."

He's not totally without his senses, I surmised, without saying as much.

"Somebody took a picture of an odd sort of fellow that came through here several years ago; I wonder if that was Pruitt?"

August 15

Didn't see much of the world today as I was on transmitters, as the phrase is known. In reality you spend half

The Answer
TO YOUR
PROCUREMENT PROBLEMS
MAY LIE
BETWEEN THESE COVERS!

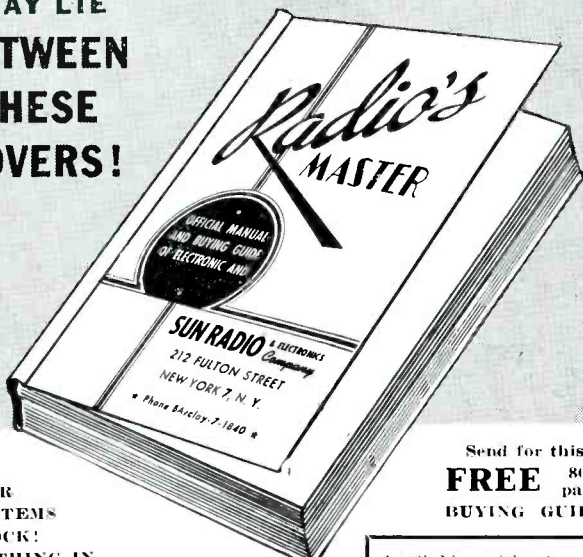

Send for this
FREE 800 page
BUYING GUIDE

Available without cost to authorized purchasing agents who write on station letterhead. Address Box BG.

OVER 10,000 ITEMS IN STOCK! EVERYTHING IN RADIO PARTS • TUBES and ELECTRONIC EQUIPMENT

Buy Another Bond —Today!

SUN RADIO & ELECTRONICS CO.
212 FULTON ST. • NEW YORK 7

Telephone
BARclay 7-1840

CONTROL APPARATUS by AUTOMATIC ELECTRIC



IN AMERICA'S leading radio broadcast studios, Automatic Electric remote control devices are used for the dependable operation of such important equipment as master control boards and announcers' cabinets, for program monitoring and switching, and for other electrical control uses.

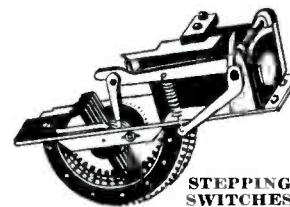

These devices have a built-in quality that is the direct result of over 50 years experience in the design and manufacture of communication, signaling, and control systems, utilizing the same engineering skill that revolutionized telephony with the automatic dial telephone.

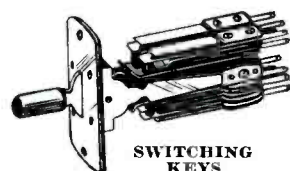

A complete engineering and consulting service is available to broadcasting studios on any electrical control problem. Avail yourself of this service today by writing—

Automatic Electric Sales Corporation
1033 West Van Buren Street
Chicago, Ill.

AUTOMATIC ELECTRIC

TELEPHONE, COMMUNICATION, AND SIGNALLING EQUIPMENT

your time under them. The other half is catching up on logs. We have here what we think is a record and a challenge in the form of twenty-three hundred log entries per day. That means that my share on an eight hour shift is exactly seven hundred sixty-six. To be more explicit, one every thirty-seven seconds. You can readily see that after giving a couple of listens to be sure that the water is boiling in the tube jackets properly, and regular trips to the pencil sharpener, one is left with time enuff for two coughs, one



As the gang at WLW visualize author Bert Pruitt on a Ghost-Catching mission, as related in the May '44 Journal, complete with frontier type radar!

sneeze, and a drink of water. (The above are interchangeable if of the same time duration.)

I have been figuring we're underpaid. We are getting two cents a meter reading, and at the two-fifty I once worked at, I was collecting fifty cents a head for reading meters.

August 22

B. G. (Gregg) spent two and a half hours looking like an engineer tonight as he was writing an instruction book on the tube tester he just completed.

"Tube tester"—he built it in the basement and since we have no derrick or roadable ramp in the building, we henceforth check our tubes in the basement.

This one carries the serial number "2" on it as the first one met an interesting fate. B. G. was pushing it into the stock room in the basement one evening when about finished, and one of the wheels tripped on a drain and the beast did a tango with a left hand spin onto its face.

Meters, transformers, et al. tore loose and piled up neatly in a heap on the stock room floor, a proper place for loose parts.

Mason is an interesting place these days and we kinda dread the end of the war when our wives and visitors will again invade this serene masculine paradise.

NEW LETTER CONTEST

for SERVICEMEN!

ELEVEN 1st PRIZE WINNERS IN 5 MONTHS IN CONTEST No. 1!

Yes sir, guys, the hundreds of letters received were so swell that *double* first prize winners had to be awarded each of the first four months and there were *triple* first prize winners the fifth and last month . . .

SO — HERE WE GO AGAIN!

Get in on this NEW letter contest — write and tell us your *first hand* experiences with *all* types of Radio Communications equipment built by Hallicrafters including the famous SCR-299!

RULES FOR THE CONTEST

Hallicrafters will give \$100.00 for the best letter received during each of the five months of April, May, June, July and August. (Deadline: Your letter must be received by midnight, the last day of each month.)

For every serious letter received Hallicrafters will send \$1.00 so even if you do not win a big prize your time will not be in vain.

Your letter will become the property of Hallicrafters and they will have the right to reproduce it in a Hallicrafters advertisement. Write as many letters as you wish. V-mail letters will do.

Military regulations prohibit the publication of winners' names and photos at present . . . monthly winners will be notified immediately upon judging.



BUY A WAR BOND TODAY!

THE HALLICRAFTERS CO., MANUFACTURERS OF RADIO AND ELECTRONIC EQUIPMENT, CHICAGO 16, U. S. A.



PEGGY AND HENRY DOTH WED

H. L. "Pete" Cavanaugh, NBC studio, became the husband of Miss Peggy Leitch at her home in Forest Park this June. Congratulations and heart-felt sympathy has been extended. Watch this column for further developments.

Chicago Chapter Chatter

By Arthur Hjorth

BEV. FREDENDALL, transmission engineer and councilman for the supervisory group, has been elected chairman of the Chicago Chapter.

The New York Chapter was well represented at the two political conventions in Chicago with G. M. "Jerry" Hastings, A. G. "Art" Poppele Maintenance, Al Wies of Field, all NBC, and C. M. "Tony" Hutson and Irving Grabo from Blue Field.

* * *

The 132-foot yacht "DOLPHIN," owned by Commodore Ralph Brooks recently had a motley crew of anglers aboard. Fishermen Lanterman, Rife, Elkins, Wilson and Baisley combined

their efforts to haul in a mess of five perch weighing nearly two pounds in all, before they were cleaned and eaten by Marguerite and Ralph Brooks the following day. NBC 1944 GREAT LAKES STRING ANGLER Art Elkins exerted the greatest effort contributing three "little fishes".

Frank E. Golder of the NBC Supervisory Group has been appointed Secretary-Treasurer by Chairman B. F. "Bev" Fredendall. His first task is a tuffy, to collect the ten extra bucks due the national office as of July 1st.

Al Eisenmenger, NBC studio, has resigned to become technical recording director for Dancer-Fitzgerald-Sample Agency.

H. B. "Herb" Wyers with WLS studios since '41 has gone to San Antone, Texas, to open a recording studio for himself.

Chicago boasts of the largest array of high ranking engineers in the service with Lieut. Col. Clark, Lt. Col. Shidel and Majors Bernheim, Sturgess and Washburn.

C. A. P. Lieut. Ed. Holm as Communications Officer has been doing quite a bit of observing from planes for the past two years. Being curious as to how and why a plane flies, Lt. Holm now has twenty-one flying hours to his credit and by gum, 8¾ of those hours are solo. He'll show 'em!

Result of balloting for Councilman by the NBC Supervisory Group revealed that the thirteen members selected seven candidates. Seems that a few voters didn't cast their ballot for themselves.

The Recording Department glistens with a new coat of paint, R. S. "Dave" Davis Supervisor has a real coat of tan and Minor Wilson can give you a good one in the fifth at Hawthorne.

Happy wedding memories to Celia and Bill Anderson (16), Lorraine and Carl Cabasin (+), Violet and Andy Forgach (16), Evelyn and Hunter Reynolds (18).

No news from the transmitters or WOW or even KODY, but we'll turn the heat on 'em before next month.

FOUR BASIC CONTROLS

for Signal Corps Equipment

. . . All helping to
"Get the Message Through," all
 proved in the precision tradition
 of **BLILEY ELECTRIC**

Do More Than Before—
Buy EXTRA War Bonds

BLILEY ELECTRIC COMPANY

UNION STATION BUILDING ERIE, PA.

Authorize UHF Relays

(From FCC Press Release 76172, June 20, 1944)

A significant type of experimentation was authorized by the Federal Communications Commission today when it granted the American Telephone and Telegraph Company conditional grants for construction permits for two experimental (Class 2) radio stations, to be located at New York, N. Y., and Boston, Mass., respectively, which are to be terminal points of a proposed wide-band, point-to-point radio repeater circuit capable of relaying telegraph and telephone communications, frequency modulation, facsimile or television broadcasting.

The Commission authorized the use by the AT&T of 12 bands of frequencies (each ranging from 11 to 23 megacycles in width) in the ultra- and super-high frequency range. This is a departure from the Commission's usual practice of authorizing specific frequencies rather than bands of frequencies.

The FCC pointed out in its authorization that the AT&T facilities were to be used only for experimental and not for commercial purposes, although commercial traffic may be diverted to these facilities for test purposes only, provided that other adequate facilities, over which such traffic would normally be carried, remain available during such diversion. However, no charge may be made for transmission of television and frequency modulation broadcast programs which takes place in whole or in part over these facilities.

The stations were authorized for unlimited time operation, with power of 10 watts, in the following frequency bands:

- 1,914,040 kc to 1,925,960 kc incl.
- 1,974,010 kc to 1,985,990 kc incl.
- 2,193,900 kc to 2,206,100 kc incl.
- 2,253,870 kc to 2,266,130 kc incl.
- 3,993,000 kc to 4,007,000 kc incl.
- 4,052,970 kc to 4,067,030 kc incl.
- 4,292,850 kc to 4,307,150 kc incl.
- 4,352,820 kc to 4,367,180 kc incl.
- 11,489,250 kc to 11,510,750 kc incl.
- 11,689,150 kc to 11,710,850 kc incl.
- 12,288,850 kc to 12,311,150 kc incl.
- 12,488,750 kc to 12,511,250 kc incl.

Broadcast Engineers' **21**
Journal - August, 1944

The Key to PERMOFLUX Efficiency

... Flat
Frequency
Response!

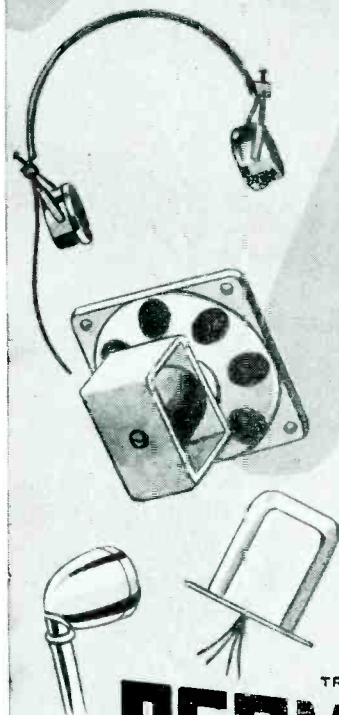

Permoflux Engineering Means Faithful Speech Reproduction

After Victory, Permoflux Acoustical Developments which today provide superior intelligibility to America's fighting voices, will give improved fidelity to millions of entertainment instruments. There will be Permoflux Engineered Devices for all sound transmission requirements.

BUY WAR BONDS FOR VICTORY!

TRADE MARK
PERMOFLUX

PERMOFLUX CORPORATION
4916-22 W. Grand Ave., Chicago 39, Ill.

PIONEER MANUFACTURERS OF PERMANENT MAGNET DYNAMIC TRANSDUCERS

Hudson Chapter NABET News

By
Richard H. Davis

ELECTION RETURNS: Howard Donniez of the Election board reports that the balloting has been concluded and the results are as follows:

George Riley TE (Present Chairman) 36 Votes.
Ralph Schlegel Recording 28 Votes.

Riley will continue in the office of chairman with the best wishes of the Hudson Chapter and support in continuing the good work as in the past year.

FIFTH WAR BOND DRIVE: The transmitters of WOR and WBAM report 100 percent sales in the Fifth War Loan. The studios and recording have not reported as of this date but the percentage is very high. The councilmen were responsible for the good showing. The WOR Bond Drive Unit which ran 14 out of town Bond Rallies sold \$18,366,000 worth of E Bonds. A good portion of the credit goes to the engineers who handled the PA and Radio ends of the shows. A hand goes to the remote group under "Mac" Reid, Messrs. Nilson, Barton and DaCosta.

ENGINEERING? Did you see the functions of Musician-Engineers as Petrillo would like them in a recent issue of "Broadcasting"? If not the July issue of Electronics have a reprint. We can add a few more but they would only confuse the issue.

SPECIAL EVENTS: Herman Berger proved himself

quite a hero the other day, and in doing so was instrumental in helping the Fifth War Loan. While passing 43rd Street on Broadway on the way to the Taft he suddenly noticed a truck slowly bearing down on the crowds watching the entertainment at the War Loan Booth at Times Square. His second glance revealed that there was no driver. Quick like a bunny, Herman jumped up on the truck and stopped it. At this point the minions of the law converged on the truck and Herman had a difficult time convincing the law that he was not the driver of the truck but a WOR engineer and that the show must go on.

TRIVIA: Have you noticed how many engineers seem to have business in the air conditioned Record Library during the recent heat wave or is it the scenery. **Jim O'Connor MC** after that long night stretch wearing dark glasses as he says, "to get used to the sunlight gradually". **Schlegel Rec.** Suping the new floors in the recording studios, they are supported on springs, etc., to prevent acoustic radiation.

This actually happened:

Davis: I've just moved to Closter.

Riley: Is that nearer?

Davis: No, Closter.

"Pappy" Davis of Maintenance a fisherman of no mean

(Continued on Page Twenty-three)

ELECTRONIC (COMMUNICATIONS) ENGINEERS WANTED

Openings in our permanent organization for several capable engineers with experience and initiative, trained in both designing and production problems in our or closely allied field.

Our line includes the designing and manufacturing of attenuators, switches, and audio test equipment.

We anticipate no readjustment in our engineering staff as a result of peace-time production requirements. In applying, kindly state qualifications and earliest availability. All inquiries will be held in strict confidence.

THE DAVEN CO.

191 CENTRAL AVE.
NEWARK 4, N. J.

Radio Communication Soon To Be Utilized by Railroads

(From FCC Release No. 76308,
June 28, 1944)

The commission on June 27 designated September 13, 1944, for the initial hearings to begin in the matter of investigating the establishment and use of radio communications systems in railroad operations, and appointed a committee composed of Commissioners Walker (Chairman), Case and Jett to preside at such hearing.

The Commission points out that these preliminary hearings are for the purpose of developing information which may be of assistance and guidance to all parties in carrying out their further programs on the subject of the use of radio on railroads. No immediate determination of policy is contemplated, but the Commission expects to keep the matter open for a period sufficient to enable all persons to complete all reasonable experimentation and to acquire all necessary data. Ample time will be

permitted for experimentation and development of further data, and further hearings will be held in the future as the need therefor may appear.

Testimony of witnesses from such organizations as the Association of American Railroads, Aeronautical Radio, Inc., Civil Aeronautics Administration, Radio Technical Planning Board, War Department, etc., will be taken at the hearing.

Interest in the use of radio by railroads has reached an all-high peak as witnessed by the fact that 30 applications for construction permits have been filed with the Commission since May 1, 1944. Some of these have already been granted. Interest is also being shown in carrier-current as well as space radio systems. One railway company, the Denver and Rio Grande, has requested that frequencies be assigned to it on a regular basis and has filed an application for such facilities.

Hudson News (Continued from Page Twenty-two)

fame reports his catch of strippers is getting pretty high. We haven't found out what bait he uses though. He also reports that his boat which he rescued from the termites has finally hit the water. Now all he has to do is get some gas to run it, hi.

More Trivia. When Tele opens up we hear that the engineers will get credit as the sound men in the movies do, so we hear.

Jim Gavigan TE staying out at Point Lookout, L. I., for the summer. His specialty is a dip in the surf before breakfast. The 10 meter DX hounds will be glad to hear that the South Pacific has some fancy dx records hung up for these low power command sets. They were supposed to have a range of 10 miles. **Dick Borner** ME the soft ball addict has moved a half block nearer Central Park. This way he can play two more innings. His team has played a number of local clubs and has one win over NBC. The box score is not available however, hi. When an engineer calls in for a line test in England, master control says, "Give me a contribution" . . . Over here that's a good way to be alone. **Bill Boher** MC spending his days off finding good spots on Long Island for fishing. He expects to spend his vacation there and reports that the "she shore" is swell. **Bert Harkins** MO in Chicago for the conventions checking on wire services and cool places to stay. **Frank Garuffy** TE at Island Beach, Conn., for his vacation adding several pounds due to a flock of NE clam bakes under his belt. **Geo. Robinson** TE acting Supvr. reports from Manasquan, N. J., by post card. A 3 pound blow fish is the "Kill" so far.

The sound effects department is sleuthing about to find out who relabled the "bell and buzzer" board, hi. **Ed. Leach** SE expecting a new sound effect any day now. Well cul until next month.

New engineering appointments at the Los Angeles plants of the Hoffman Radio Corporation include that of William W. Wells as a senior engineer. He went west several years ago from the Colonial Radio Corporation and became a department supervisor with the Universal Microphone Company, Inglewood, and more recently with Marine Radio at Wilmington. He has been assigned to engineering duties on war contracts.

William J. Green is another new senior engineer. He was an engineer with the Radiobar Company for five years. When Radiobar was merged with Philco, he was with their Philadelphia plant for six years before going west to Los Angeles.

Roy Deane has also joined the staff of the Hoffman Radio Corp., as a production supervisor. He has spent a lifetime in electrical, automotive and radio circles and entered radio some time ago as foreman and superintendent with the former Grigsby-Grunow Company for five years. His most recent post, before going west, was as general works manager for Fractional Motors in Chicago.

CAPPS*

SAPPHIRE is, and has always been, the only material for making cutting styli for high class recordings.

CAPPS* Patented Sapphire Styli (2187512) are the original and accepted standard for high class professional acetate recordings.

Imitated but not equalled

FRANK L. CAPPS & CO.

244 W. 49th STREET NEW YORK CITY

Telephone Circle 6-5285

* Reg. U. S. Pat. Off.

Aaron Lippman & Co.

246 Central Avenue Newark, N. J.

Radio and Electronic Equipment

We Expedite — Ask Anyone

Courmettes & Gaul OPTICIANS

55 West 49th Street

R. C. A. Building (Main Floor), New York

EYE EXAMINATIONS

Prescriptions Filled . . . Prompt Repair Work

Invisible Contact Lenses Fitted

The WINKER SYSTEM

By Bert Pruitt

WE WRITE this for the benefit of WTAM's technicians stationed on our various battle fronts. From the letters we receive it is obvious these men are looking forward to the day when they'll again twist faders and stretch their arms with portable field equipment here in Cleveland.

We realize these fighting WTAM'ers should be kept advised as to what is happening on the Broadcast Home Front, but we do not have the time or ambition it requires to sit down and write each of them a detailed letter. That being the case, we shall attempt to give them a picture of Cleveland Broadcasting through the medium of the BEJ.

There have been quite a few minor changes since Tommy Cox, Gill Buchanan, Cecil Bidlack and others said farewell to the WTAM gang for the duration. But we believe they would be more interested in knowing of our present method of studio-control-room communication system. Most of these fellows are in the Army Signal Corps so we believe it proper to advise them we have a Winker System that is said to be far more efficient than Radar. Of course, it's true that we can't sink a battleship in Cleveland with out Winker System, on the other hand it's reasonable to assume we do things with our Winker System that they'd never attempt with Radar.

When you fellows were here we used to dash into a control room with an armful of records. We'd turn on the equipment, then begin dealing records like our wives deal cards at an afternoon session of bridge, hearts, poker, or whatever they play when they get together. Well, boys, you are due for a big surprise. Things are different now. You will recall that we used to have one clock in each control room. One look at that fortification in front of Freddy Wilson gives you an idea as to how production changes with time. He has three clocks and a stop watch to make sure chimes ring on time. I haven't been able to purchase a clock since the lightning struck our house last summer and grounded in our best time piece . . . but don't get me wrong. I'm not complaining. I realize I'm better off here in Cleveland without a clock than I'd be in a fox hole with the entire Arlington station in there with me. But as I was saying, two of these clocks are hooked together and work as follows:—Freddy starts both of them when the rehearsal starts. The one on the left keeps going and gives the total time at end of rehearsal. The one on the right can be stopped, restarted or reset like a stop watch. Charley Ames put a shaft on the stop-watch-clock. The shaft sticks out through the face of the clock, thus making it possible to go forward or in reverse with a minimum of effort. The production man still uses his stop watch but these other clocks, according to



Fred Wilson, production man, fortifies himself for a rehearsal.

the production men, have it all over the ordinary way of timing a show.

We started out on the Winker System and ended up winding clocks. We'll start again with the Winker System and do our best to end with it this time.

We have some fancy little gadgets that set in the studio on a microphone stand. These gadgets have two eyes . . . one green and the other red. The production man in the control booth can wink either green or red as the occasion demands. That seems to be an advanced step beyond the Navy's one color Blinker System. When the announcer reads too slow the production man winks a green eye and the announcer speeds up until he's going too fast, then the production man winks a red eye and the announcer slows down, so you readily see our system is most flexible.

The clocks and the Winker System work together as follows: The carrier comes up and we are ready to go . . . well, almost. The production man kicks on his clocks and winks a green eye. This advises the alert announcer he has already cleared his throat and is ready to talk. Then the production man unwinks his green eye and the announcer knows he is talking. There have been occasions of slight confusion when the production man came to work early in the morning and blinked three red eyes for each green one. But that, as you well know, is a circumstance beyond the control of anyone in Cleveland.

It's entirely possible that I have gotten the procedure slightly confused in the above paragraph. If interested, you should write Freddy Wilson for a detailed explanation as to the 'why' and 'wherefor' of the Winker System. He says it has many advantages . . . one advantage lies in the fact that announcers and engineers wouldn't be able to learn the wig-wag system before the Army had them. And he likes the Winker System because you can cuss a blue streak with it and never have that uneasy feeling that a microphone may be listening to everything you say.

That just about takes care of the Winker System. I'll tell you fellows about some other changes from time to time.

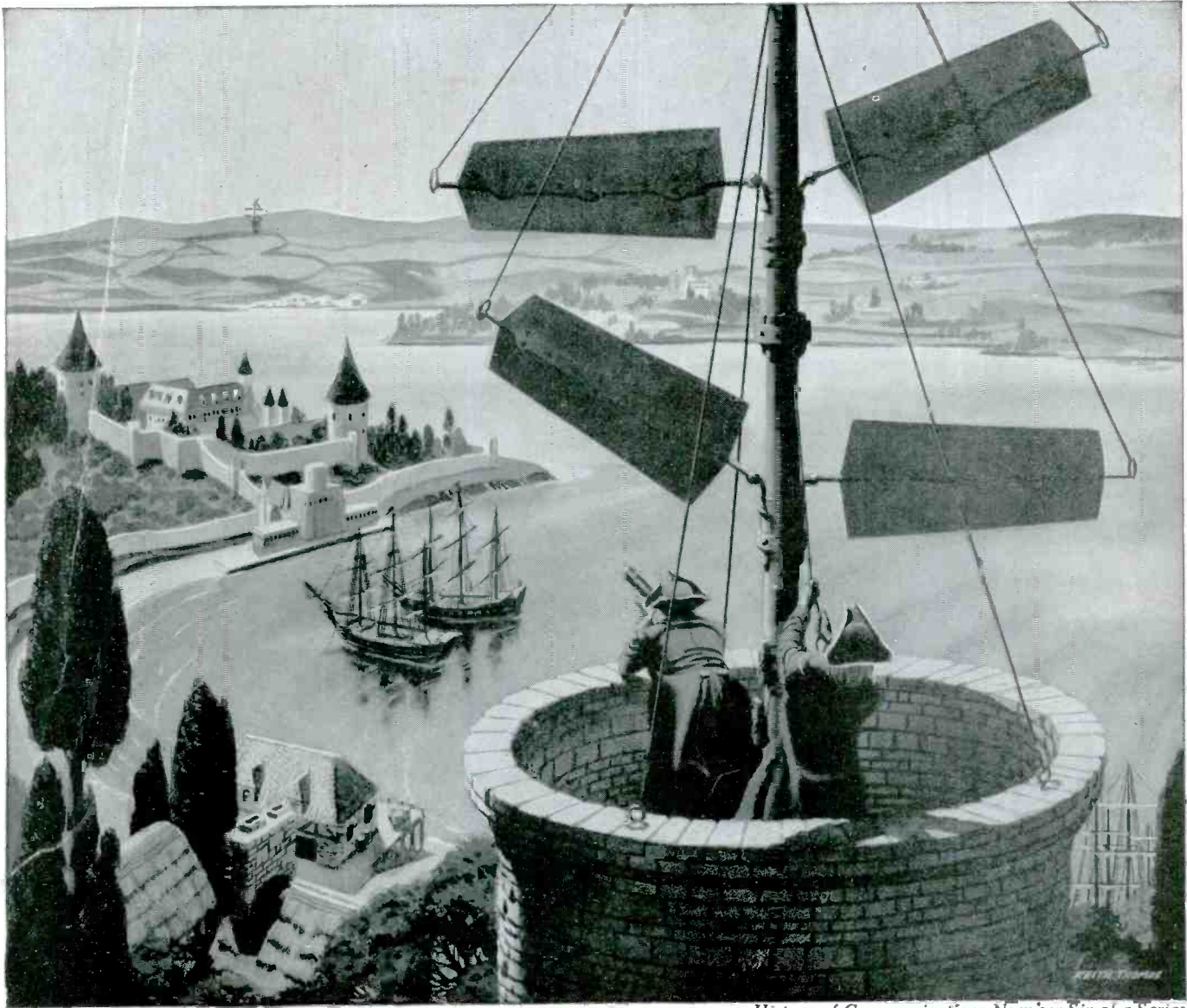

History of Communications Number Six of a Series

COMMUNICATION BY SEMAPHORE

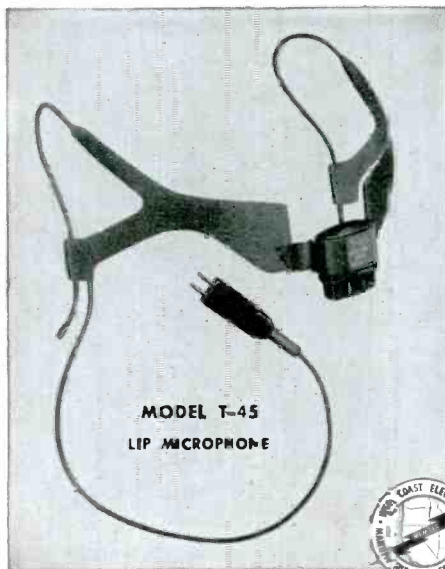

The Semaphore, as a means of communication, met first commercial acceptance in France under the authority of Napoleon in 1792. Restricted by "line of sight" and low power eye pieces, excessive numbers of relay stations, as pictured above, were required for "directional broadcasting" over rough terrain. Weather conditions, too, were a handicap. Because of the code used and its necessary translation, delays and errors were continually encountered.

Today, in the era of applied electronics, Universal microphones are being used to expedite messages on every battle front in the service of the Allies. Universal is proud of its contribution in the electronic voice communications and its every effort to our ultimate Victory.

Model T-45, illustrated at left, is the new Lip Microphone being manufactured by Universal for the U. S. Army Signal Corps. Shortly, these microphones will be available to priority users through local Radio Jobbers.

UNIVERSAL MICROPHONE COMPANY
INGLEWOOD, CALIFORNIA



FOREIGN DIVISION: 301 CLAY STREET, SAN FRANCISCO 11, CALIFORNIA -- CANADIAN DIVISION: 560 KING STREET WEST, TORONTO 1, ONTARIO, CANADA

FIXED ATTENUATORS ENGINEERED by DAVEN



DAVEN Fixed Attenuators are available in any desired impedances, and any loss from minimum for the selected impedances upward. Extensively used in major broadcasting and motion picture sound studios, and for laboratory standards of attenuation, **DAVEN** Fixed Attenuators are backed by years of experience and skill. Our engineers will gladly cooperate on special problems.

RECTANGULAR: TYPE 153 ... 3 $\frac{3}{8}$ " high x 1 $\frac{1}{2}$ " long x 1 $\frac{1}{8}$ " wide (overall), height of standard key-lever switch.

TYPE 154 ... 1 $\frac{3}{4}$ " high x 1 $\frac{1}{2}$ " long x 1 $\frac{1}{8}$ " wide (overall), approx. half height of key-lever switch.

CYLINDRICAL: TYPE 950 ... 1 $\frac{1}{16}$ " diameter x 1 $\frac{1}{8}$ " long, for use in small space; mounts with No. 6 screw through center hole.

TYPE 1030 ... 1 $\frac{1}{8}$ " diameter x $\frac{7}{8}$ " long, type for tapped fixed attenuators; mounts with No. 6 screw through center hole.

PLUG-IN: TYPE 691 (octal tube base) ... 1 $\frac{3}{8}$ " diameter x 3" long; provides convenience in interchanging fixed value networks.

CIRCUITS: "T" or Bal. "H", and where required, "L", "U", "O", " π "

DAVEN Fixed Attenuators are precision-built of accurately adjusted, card-type resistors, non-inductively wound on bakelite strips. Standard accuracy $\pm 2\%$ (type 691, $\pm 1\%$), closer tolerances available on request. Properly aged to retain accurate characteristics. Mounted in metal shielding. Wattage, maximum dissipation 1 watt (type 950, 0.6w), special units to 20 watt.

DAVEN SPECIAL FIXED ATTENUATORS: Multiple output networks (size of type 153)
Medium wattage networks (up to 20w. type 153) Tapped fixed networks (type 1030)

YOU CAN HELP SPEED V-DAY BY BUYING WAR BONDS

THE **DAVEN** COMPANY

191 CENTRAL AVENUE
NEWARK 4, NEW JERSEY